

# Abdichtungs-Set DallSafe 200

720252

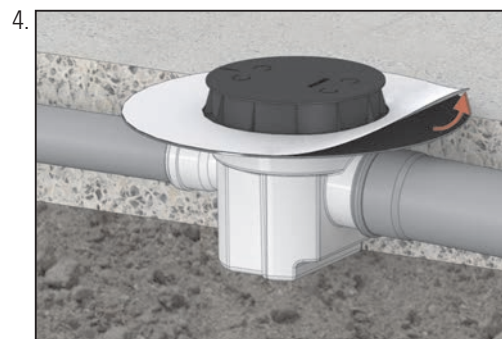
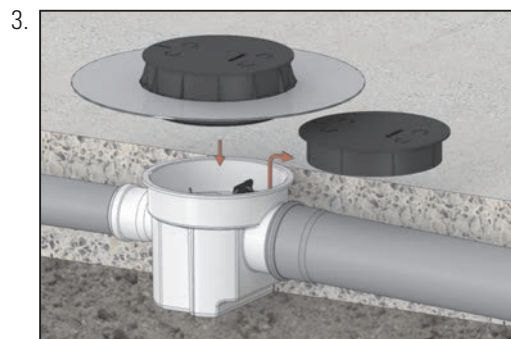
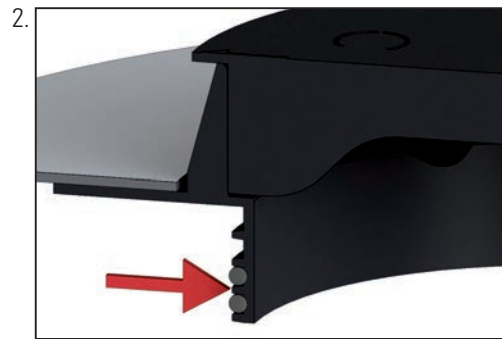
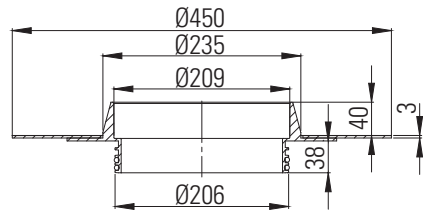

**DALLMER**

# Abdichtungs-Set DallSafe 200

720252

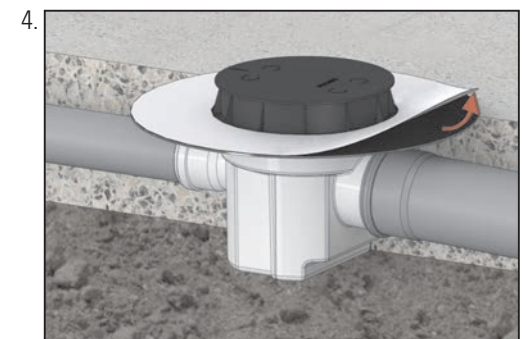
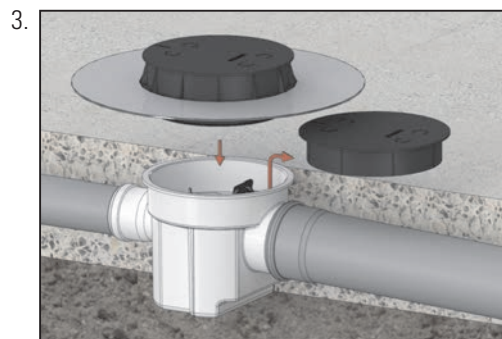
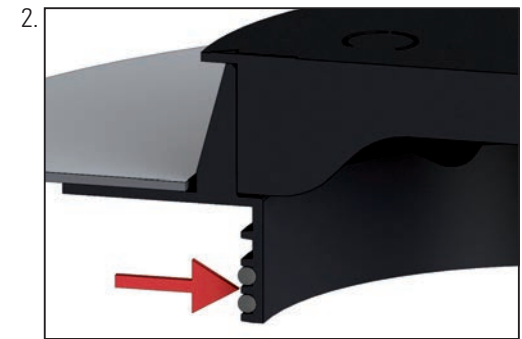
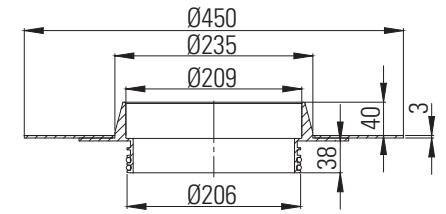

**DALLMER**

## Abdichtungs-Set DallSafe 200

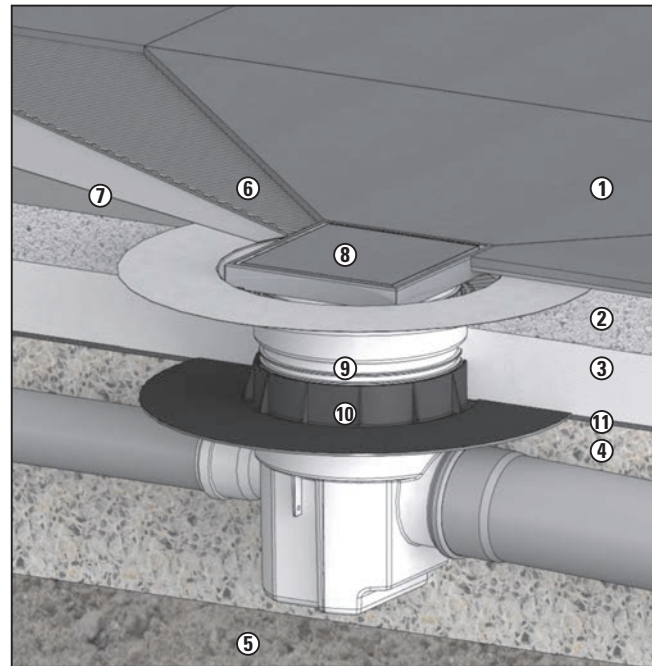
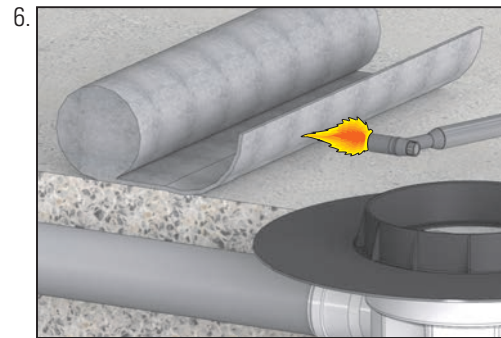
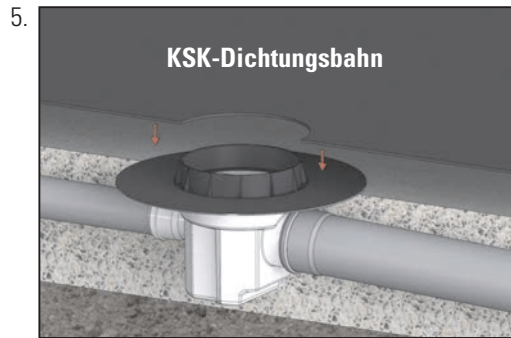

- ① Bodenbelag / Fliese
- ② Estrich
- ③ Wärmedämmung
- ④ Beton
- ⑤ Schotter
- ⑥ Fliesenkleber
- ⑦ Verbundabdichtung
- ⑧ 200/1 Stone (720221)
- ⑨ Aufstockelement (720245)
- ⑩ Abdichtungs-Set (720252)
- ⑪ Abdichtung

## Abdichtungs-Set DallSafe 200

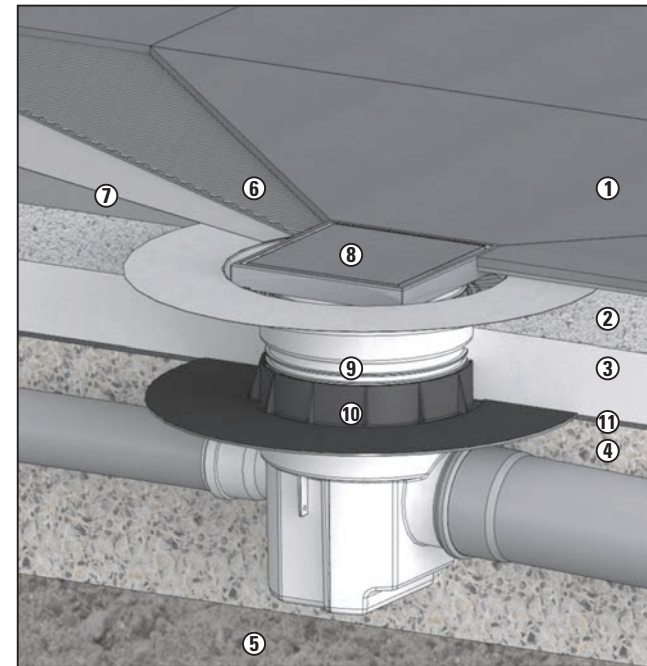
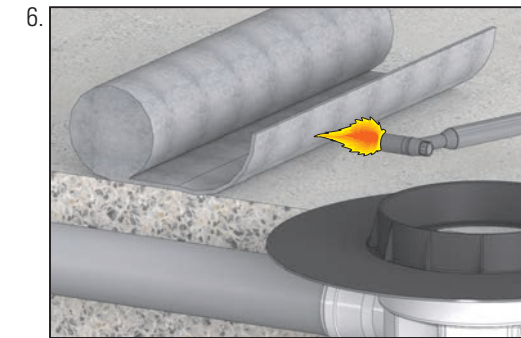
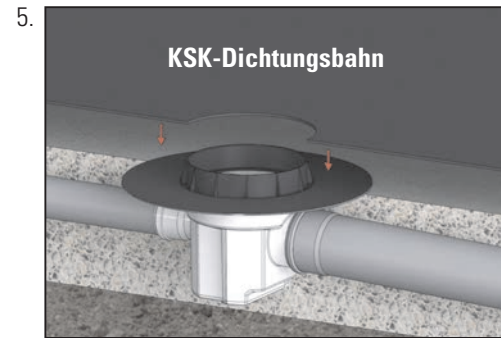

- ① Bodenbelag / Fliese
- ② Estrich
- ③ Wärmedämmung
- ④ Beton
- ⑤ Schotter
- ⑥ Fliesenkleber
- ⑦ Verbundabdichtung
- ⑧ 200/1 Stone (720221)
- ⑨ Aufstockelement (720245)
- ⑩ Abdichtungs-Set (720252)
- ⑪ Abdichtung