

DE Montageanleitung

EN Mounting instruction

ES Instrucciones de instalación

FR Instructions d'installation

IT Istruzioni per l'installazione

NL Montagehandleiding

CS Návod k instalaci

PL Instrukcja montażu

RU Инструкция по монтажу

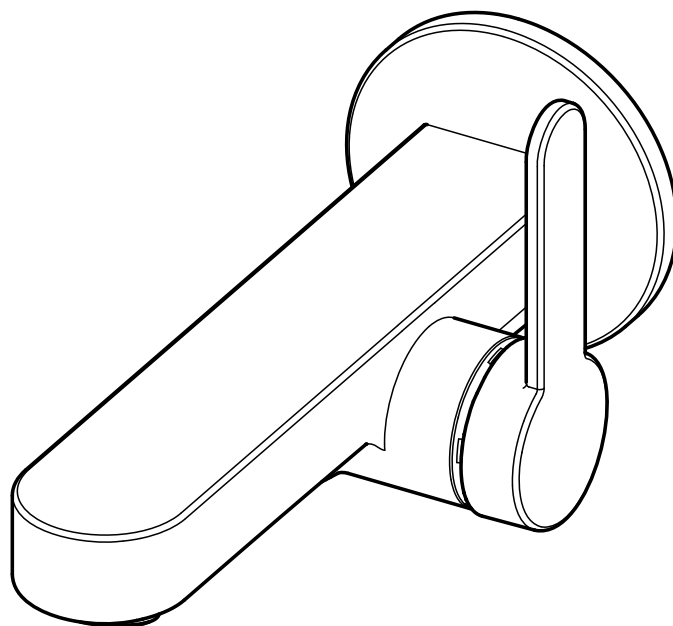

59516 XX0301 59516 XX1301

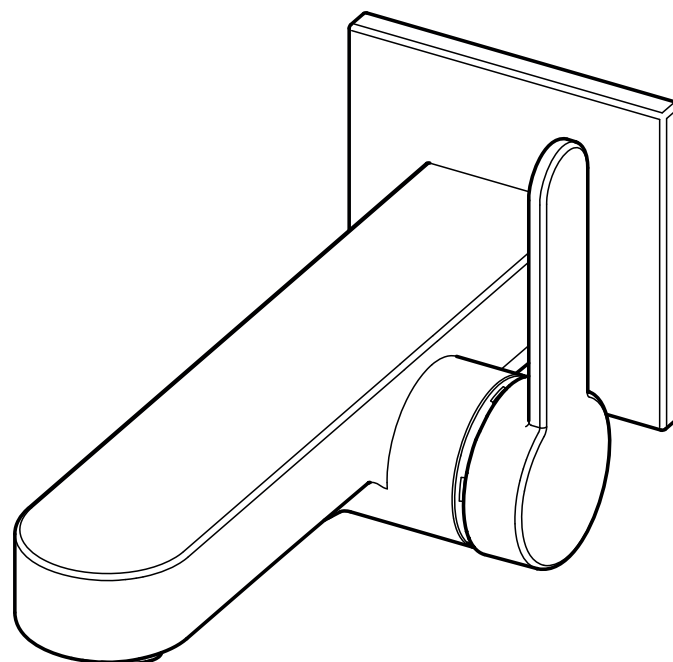

59516 XX0302 59516 XX1302

DE Einbaumaße

FR Cotes de montage

CS Montážní rozměry

EN Mounting dimensions

IT Ingombro

PL Wymiary montażowe

ES Dimensiones de montaje

NL Montageafmetingen

RU Монтажные размеры

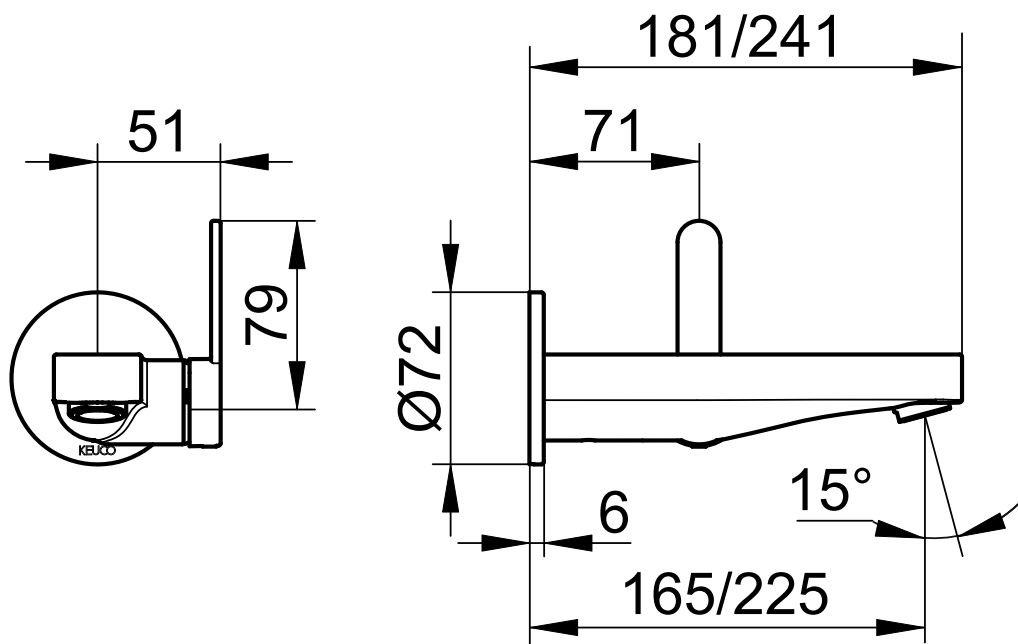

59516 XX0301 (165 mm)

59516 XX1301 (225 mm)

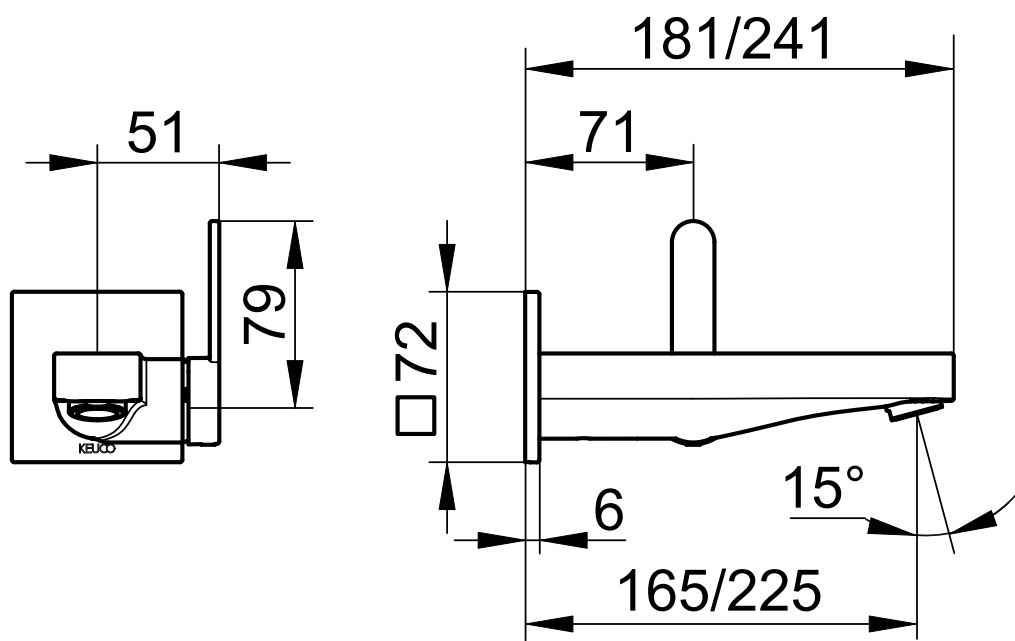











59516 XX0202 (165 mm)

59516 XX1202 (225 mm)

 Diese Anleitung ist für den Installateur zur Montage sowie für den Nutzer zur Bedienung und Wartung des Produktes. Bitte nach der Installation an den Nutzer zur Verwahrung weitergeben.

Symbole und Bedeutung

-  **Achtung!** Warnung vor Personen- oder Sachschaden.
-  Hinweis, Tipp oder Verweis
-  Falsche Montage
-  Korrekte Montage/Funktionsprüfung
-  Montagedetail beachten
-  Kaltwasser  Warmwasser
-  Wasserfluss  Kein Wasserfluss
-  Optional/Zubehör

Verwendungszweck

 Einhebelmischer für die Verwendung in Badezimmer und WC.

Technische Daten

– Durchfluss bei 3 bar Fließdruck: ca. 7,6 l/min

Einbaumaße, siehe Seite 2.

Installation, siehe ab Bild 1 auf Seite 8.

 Trinkwasserleitungen vor und nach der Installation gründlich spülen (EN 806 und 1717 sowie DIN 1988 beachten).
Nur neutral vernetzendes Silikon verwenden.

Bedienung, siehe Bild 9 auf Seite 9

Wartung, siehe Bild 10 und 11 auf Seite 9











Montage in umgekehrter Reihenfolge.
– Anzugsmoment Kartuschenmutter: 12-13 Nm

Ersatzteile mit Bestellnummern, siehe Seite 11.

 Hinweise zur Gewährleistung und Pflege sind dem beiliegendem **Pflege- und Garantiepass** zu entnehmen.

 These instructions are for both the installer for installation and the user for operation and maintenance of the product. After installation, please hand them over to the user to keep.

Symbols and explanations

-  **Attention!** Warning against bodily injury or damage to property.
-  Note, tip or reference
-  Incorrect installation
-  Correct installation/test of functionality
-  Observe installation details
-  Cold water  Hot water
-  Water flow  No water flow
-  Optional/accessories

Intended use

 Single lever mixer tap for use in bathrooms and WCs.

Technical specifications

– Flow at 3 bar pressure: approx. 7.6 l/min

Installation dimensions, refer to page 2

Installation, refer to picture 1 on page 8

 Flush potable water pipes thoroughly before and after installation (observe EN 806 and 1717).
Use only neutrally netting silicone.

Operation, refer to picture 9 on page 9

Servicing, see refer to picture 10 and 11 on page 9



Assemble in reverse order.
– Cartridge nut torque: 12-13 Nm

For spare parts with order numbers, refer to page 11.

 For warranty and care information please refer to the attached **warranty and care instructions**.

 Este manual está dirigido al instalador para el montaje, así como al usuario para el manejo y mantenimiento del producto. Por favor, después de la instalación, este manual se debe entregar al usuario para que lo conserve.

Símbolos y significado

-  ¡Atención! Advertencia de daños personales o materiales.
-  Indicación, consejo o referencia
-  Montaje erróneo
-  Montaje/comprobación de funcionamiento correctos
-  Observar el detalle de montaje
-  Agua fría
-  Agua caliente
-  Flujo de agua
-  Ningún flujo de agua
-  Opcional/Accesorios

Uso previsto

 Mezclador monomando para la utilización en el baño y en el WC.

Datos técnicos

– Paso con una presión de caudal de 3 bares:
aprox. 7,6 l/min.

Medidas de montaje, véase página 2

Instalación, véase imagen 1 en la página 8

 Lavar minuciosamente las tuberías de agua potable antes y después de la instalación (observar EN 806 y 1717).
Utilizar exclusivamente silicona de reticulación neutra.

Manejo, véase imagen 9 en la página 9

Mantenimiento, véase imágenes 10 y 11 en la página 9











El montaje se efectúa en el orden inverso.
– Par de apriete de la tuerca de fijación del cartucho: 12-13 Nm

Piezas de recambio con números de pedido, véase página 11.

 En el pasaporte de mantenimiento y garantía adjunto encontrará indicaciones sobre la **manual de mantenimiento y tarjeta de garantía**.

 Ces instructions sont destinées à l'installateur, pour effectuer le montage, et pour l'utilisateur, pour utiliser le produit et procéder à sa maintenance. Après l'installation, veuillez remettre ces instructions à l'utilisateur pour qu'il les conserve.

Symboles et leur signification

-  **Attention !** Mise en garde contre les dégâts de personnes et les dégâts matériels.
-  Remarque, conseil ou renvoi
-  Montage incorrect
-  Montage correct/contrôle fonctionnel
-  Respecter le détail de montage
-  Eau froide
-  Eau chaude
-  Débit d'eau
-  Pas de débit d'eau
-  Option/accessoires

Domaine d'utilisation

 Mitigeur monocommande pour utilisation dans la salle de bains et les WC.

Caractéristiques techniques

– Débit à une pression d'écoulement de 3 bar :
env. 7,6 l/mn

Cotes de montage, voir page 2

Installation, voir figure 1 à la page 8

 Rincer soigneusement les conduites d'eau potable avant et après l'installation (respecter les normes EN 806 et 1717).
N'utiliser que du silicone à réticulation neutre.

Utilisation, voir figure 9 à la page 9

Maintenance, voir figures 10 et 11, page 9

Le montage s'effectue dans l'ordre inverse de la dépose.
– Couple de serrage écrou de cartouche : 12-13 Nm

Pièces de rechange avec numéros de commande, voir page 11.

 Les consignes relatives à la garantie et à l'entretien figurent sur la **instructions d'entretien et carte de garantie** jointe.

 Il presente manuale è indirizzato agli installatori per il montaggio nonché agli utilizzatori per l'uso e la manutenzione del prodotto. Consegnarlo all'utilizzatore dopo l'installazione affinché lo custodisca.

Simboli e significato

 **Attenzione!** Pericolo di lesioni o danni materiali.

 Avvertenza, consiglio o rimando

 Montaggio errato

 Montaggio corretto/verifica del funzionamento

 Prestare attenzione al dettaglio di montaggio

 Acqua fredda

 Acqua calda

 Flusso d'acqua

 Nessun flusso d'acqua

 Opzionale/accessorio

Scopo d'uso

 Miscelatore monocomando per l'utilizzo in bagno e WC.

Dati tecnici

– Portata con pressione di flusso di 3 bar:
circa 7,6 l/min

Ingombro, vedi pagina 2

Installazione, vedi dalla figura 1 a pagina 8

 Prima e dopo l'installazione lavare con acqua abbondante le condotte di acqua potabile (osservare EN 806 e 1717).

Utilizzare solo silicone neutro.

Uso, vedi figura 9 a pagina 9

Manutenzione, vedi figura 10 e 11 a pagina 9

Eseguire il montaggio in ordine inverso.

– Coppia del dado della cartuccia: 12-13 Nm

Ricambi con numero d'ordine, vedi pagina 11.

 Indicazioni relative alla garanzia e al trattamento vanno desunte dalle **istruzioni di manutenzione e certificato di garanzia**.

 Deze handleiding is bestemd voor zowel de installateur voor de montage alsook voor de gebruiker voor het gebruik en het onderhoud van het product. Gelieve na de installatie door te geven aan de gebruiker om te bewaren.

Symbolen en betekenis

 **Opgepast!** Gevaar voor letsel of schade.

 Opmerking, tip of referentie

 Verkeerde montage

 Correcte montage/werkingstest

 Montagedetails in acht nemen

 Koud water

 Heet water

 Waterstroom

 Geen waterstroom

 Optioneel/toebehoren

Bestemd gebruik

 Eenhendelmengkraan voor gebruik in badkamer en wc.

Technische gegevens

– Doorstroming bij 3 bar stromingsdruk:
ca. 7,6 l/min

Montageafmetingen, zie pagina 2

Installatie, zie vanaf afbeelding 1 op pagina 8

 Drinkwaterleidingen voor en na de installatie grondig spoelen (volgens EN 806 en 1717).

Uitsluitend neutraal vernette siliconen gebruiken.

Gebruik, zie afbeelding 9 op pagina 9

Onderhoud, zie afbeelding 10 en 11 op pagina 9

Montage in omgekeerde volgorde.

– Aandraaimoment moer voor cartouche:











12-13 Nm

Reserveonderdelen met bestelnummers, zie pagina 11.

 Instructies voor de waarborg en het onderhoud vindt u in de meegeleverde **aanwijzingen voor het onderhoud en garantiebewijs**.

 Tento návod slouží instalatérům při montáži a uživatelům při obsluze a údržbě produktu. Po nainstalování ho předejte uživateli, aby si ho mohl uschovat.

Symbole a význam

-  **Pozor!** Výstraha před zraněním a věcnými škodami.
-  Upozornění, tip nebo odkaz
-  Nesprávná montáž
-  Správná montáž / kontrola funkčnosti
-  Při montáži dbejte na tento detail
-  Studená voda  Teplá voda
-  Průtok vody  Žádný průtok vody
-  Volitelná výbava / příslušenství

Účel použití

 Páková směšovací armatura pro použití v koupelnách a WC.

Technické údaje

– Průtok při průtokovém tlaku 3 bary:
cca. 7,6 l/min

Montážní rozměry viz strana 2

Instalace viz obrázek 1 na straně 8

 Potrubí na pitnou vodu před a po instalaci důkladně vypláchněte (postupujte podle EN 806 a 1717).
Používejte pouze neutrální silikon.

Obsluha viz obrázek 9 na straně 9

Údržba, viz snímky 10 a 11 na straně 9







Montáž probíhá v obráceném pořadí.
– Utahovací moment matice kartuše: 12-13 Nm

Náhradní díly s objednáacími čísly viz strany 11

 Pokyny týkající se záruky a péče najdete v příloženém **Návodu k údržbě a záručním listu**.

 Instrukcja przeznaczona jest dla instalatora, zapewniając pomoc w zakresie montażu oraz dla użytkownika, informując go o sposobie obsługi i konserwacji produktu. Po instalacji należy przekazać instrukcję użytkownikowi, aby ją u siebie przechowywał.

Symbole i znaczenie

-  **Uwaga!** Ostrzeżenie przed szkodami osobowymi i materialnymi.
-  Informacja, dobra rada lub odsyłacz
-  Niewłaściwy montaż
-  Właściwy montaż / kontrola funkcjonowania
-  Należy stosować się do danych, dotyczących montażu
-  Woda zimna  Woda gorąca
-  Strumień wody  Brak strumienia wody
-  Opcje / Osprzęt

Przeznaczenie

 Bateria jednouchwytywa do stosowania w łazience i WC.

Dane techniczne

– Przepływ w przypadku ciśnienia hydraulicznego 3 bar: około 7,6 l/min

Wymiary zabudowy, patrz strona 2

Instalacja, patrz rys. 1 na stronie 8

 Przed instalacją i po instalacji należy gruntownie przepłukać przewody, prowadzące wodę pitną (należy stosować się do EN 806 i 1717).
Należy wykorzystywać wyłącznie silikon, ulegający naturalnemu usieciowaniu.

Obsługa, patrz rys. 9 na stronie 9

Konserwacja, patrz rys. 10 i 11 na stronie 9

Montaż w odwrotnej kolejności.
– Moment obrotowy dokręcenia nakrętki głowicy: 12-13 Nm

Części zamienne z numerami zamówienia, patrz strona 11.

 Informacje dotyczące gwarancji dostępne są w dołączonej **karcie pielęgnacyjno-gwarancyjnej**.

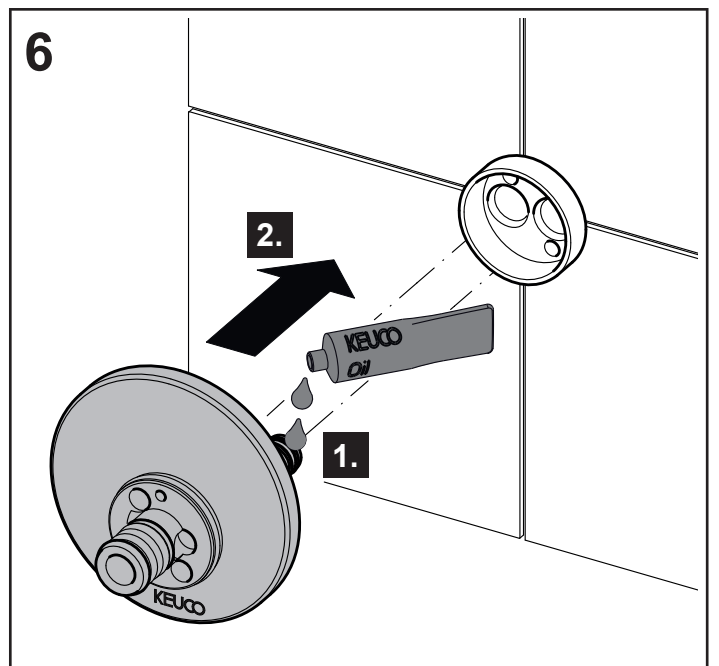
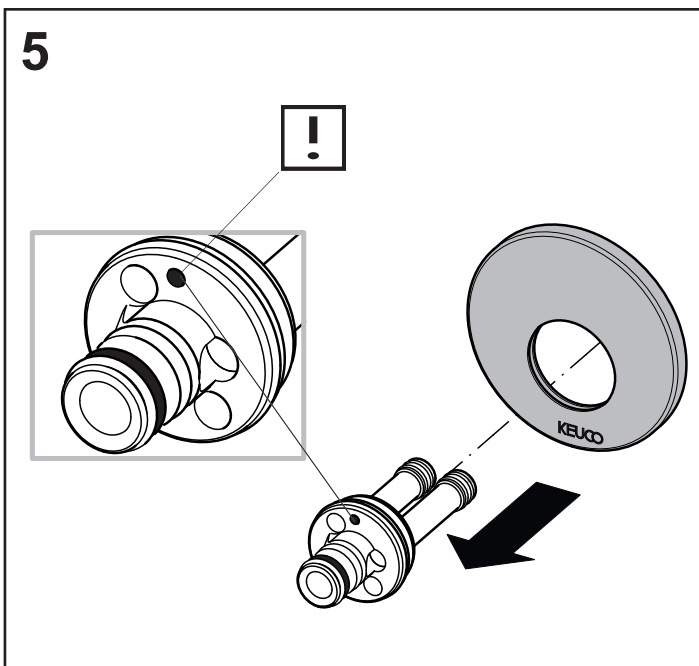
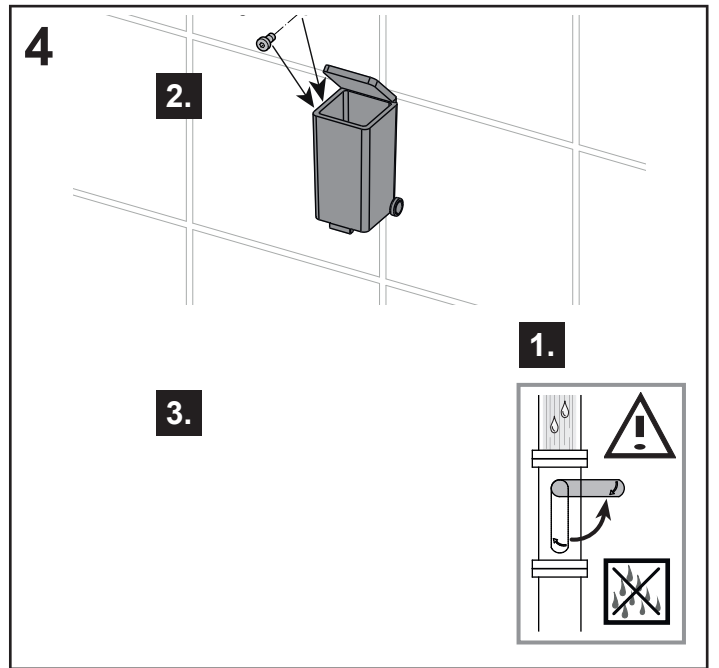
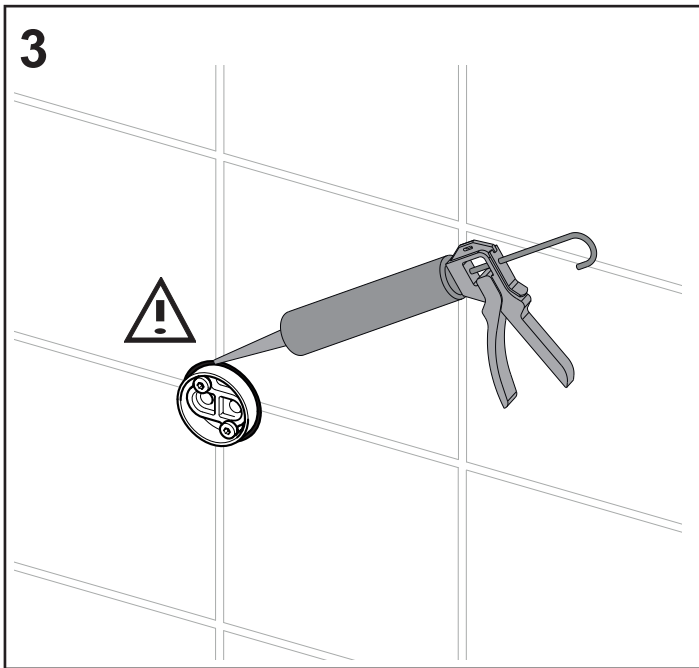
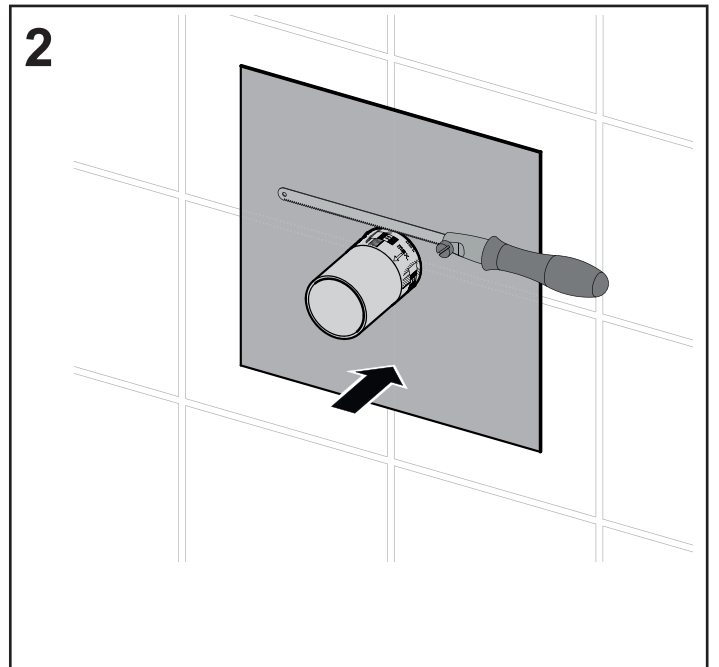
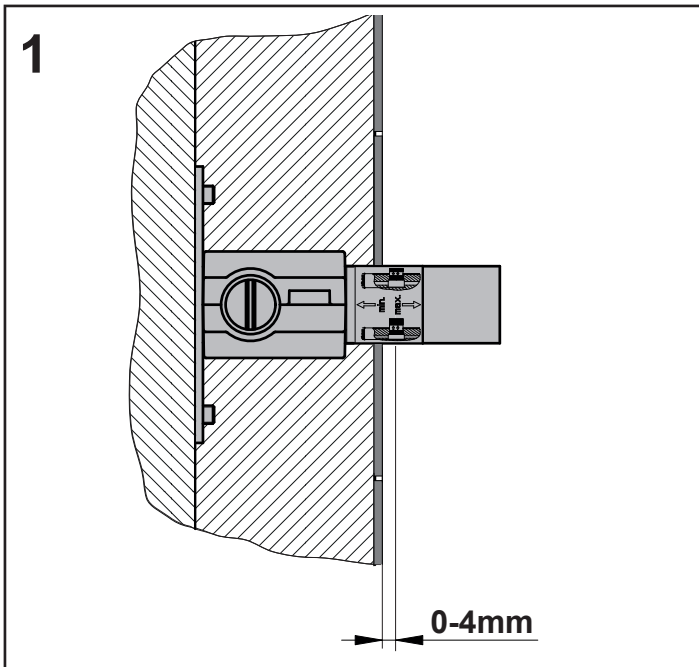

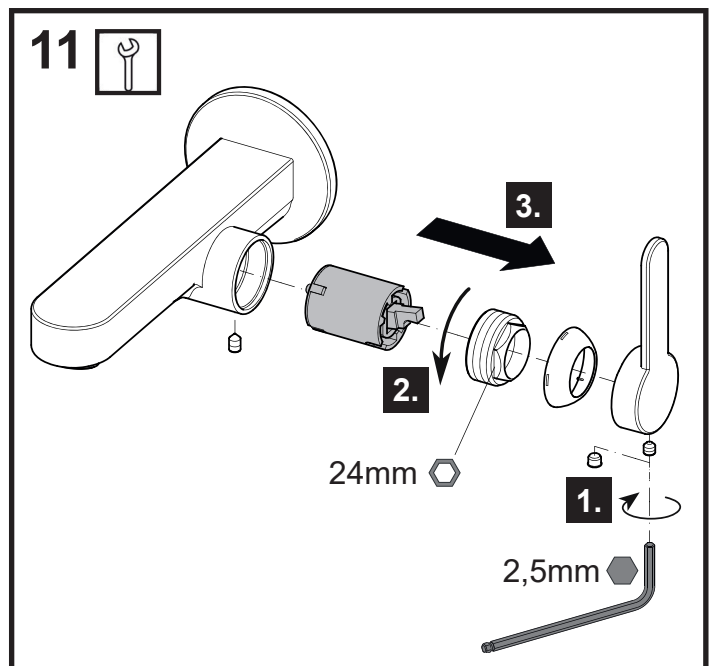
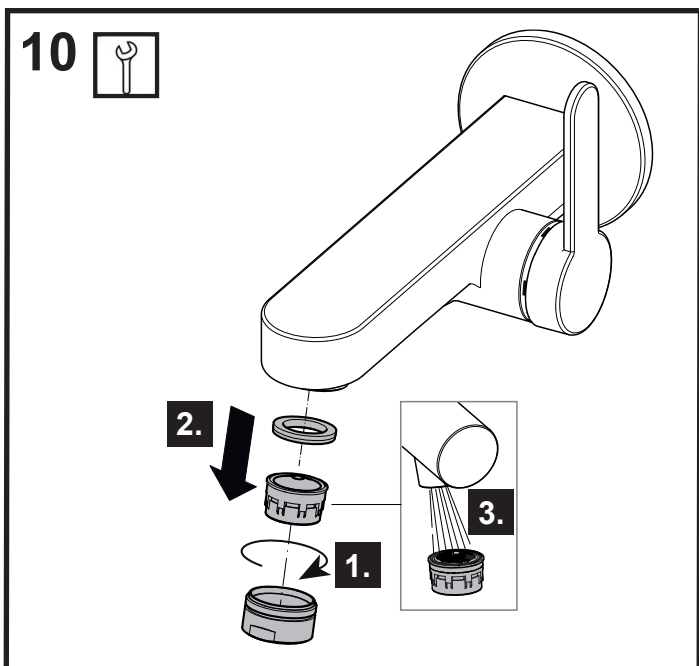
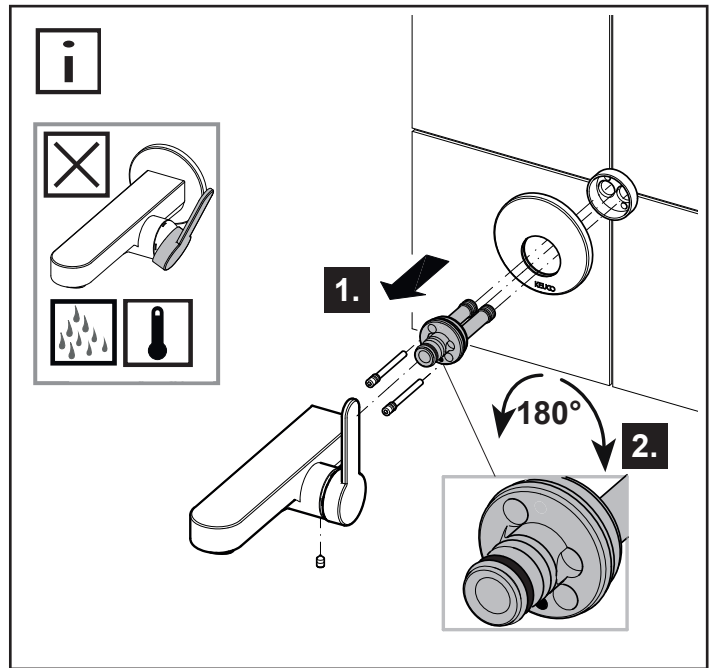
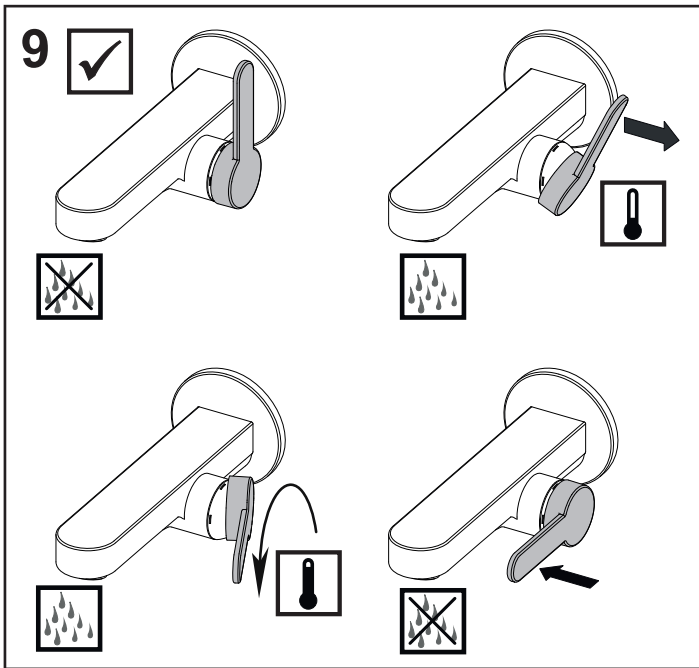
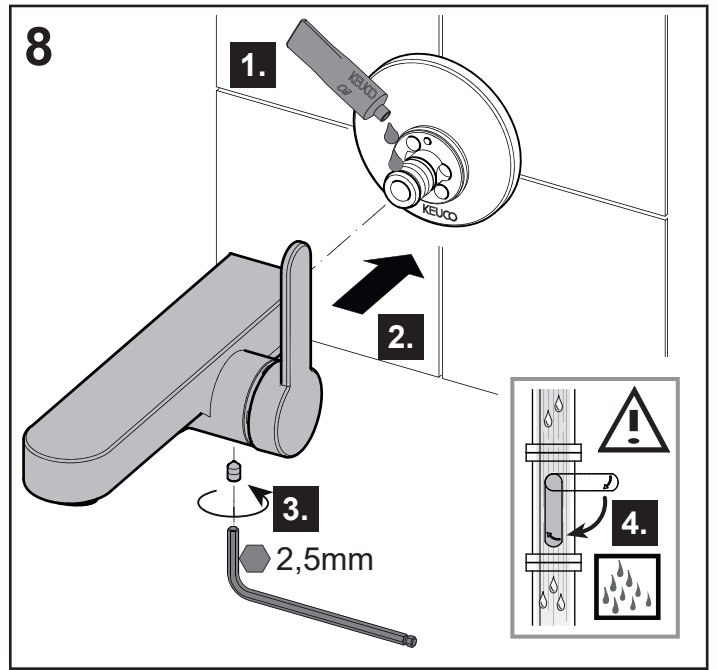
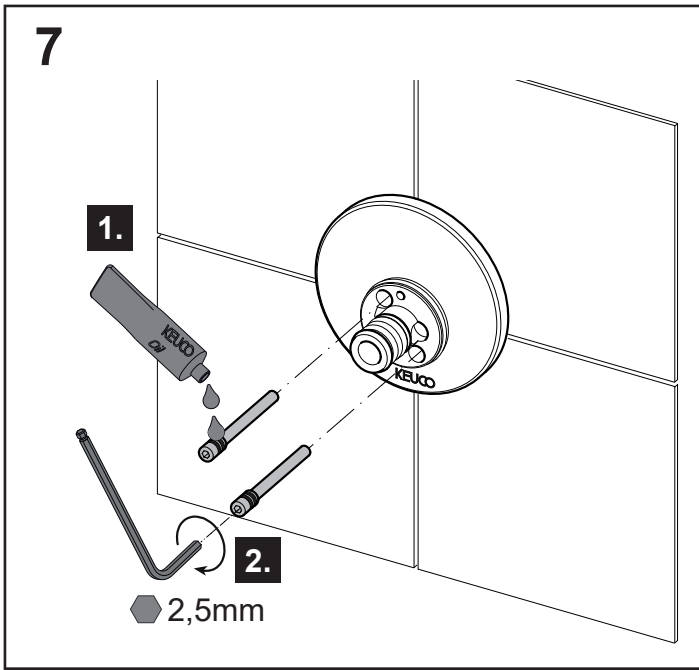



A series of 20 horizontal lines for writing, spaced evenly down the page.

DE Ersatzteile

FR Pièces de rechange

CS Náhradní díly

EN Spare parts

IT Ricambi

PL Części zamienne

ES Piezas de recambio

NL Reserveonderdelen

RU Запчасти

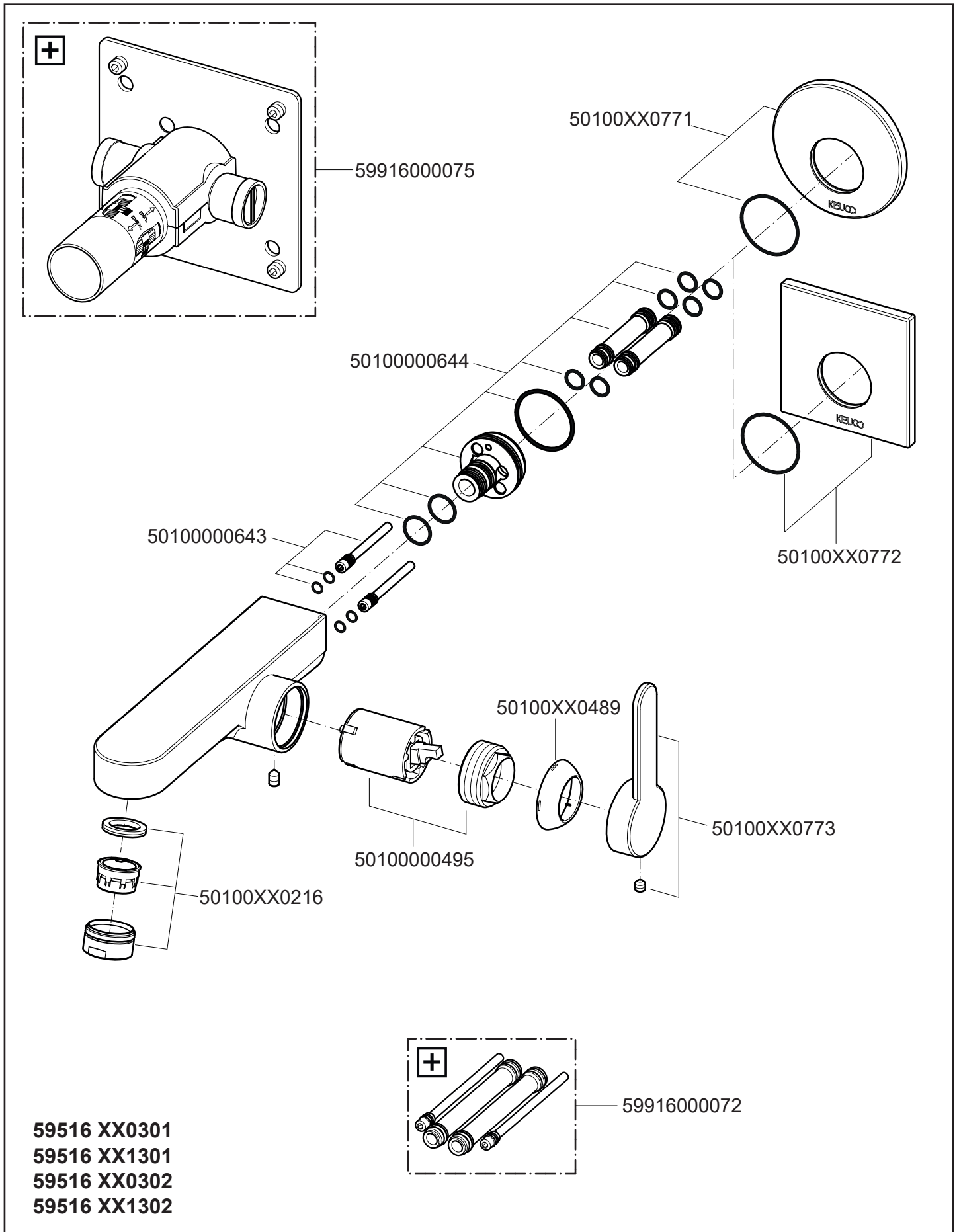

DE

KEUCO GmbH Co. KG
Oesestraße 36

D-58675 Hemer
Telefon: +49 2372 904-0
E-Mail: info@keuco.de

AT

KEUCO GmbH
Söllheimerstraße 16
Gebäude 1

A-5020 Salzburg
Telefon: +43 662 454056-0
E-Mail: office@keuco.at

CH

KEUCO AG
Willestrasse 9

CH-8957 Spreitenbach
Telefon: +41 62 888 00 20
E-Mail: info@keuco.ch

EN

KEUCO UK Ltd.
57 Sheffield Road
Dronfield
S18 2GF Derbyshire

Phone: +44 (0) 1442 865 220
E-Mail: info@keuco.co.uk

FR

KEUCO S. A. R. L.

5, Rue du Martelberg
F-67700 Monswiller

Téléphone: +33 3 88 700 200
E-Mail: bureau@keuco.fr

RU

представительство
Кеуко в России
Ленинский проспект 64/2
119296 Москва
тел. + 7 495 953 81 11
Электронная почта:
office-russia@keuco.com

US

VELLA LLC
d. b. a. KEUCO NORTH AMERICA
4485 Tench Road / Ste 1121
Suwanee
Georgia 30024
Phone: +1 (877) 281-8260
E-Mail: office@keucoamericas.com

www.keuco.com