

Theoretic Mass(kg)		Revision
Surface Area(dm ²)		A4

Thread	Hole	Shaft

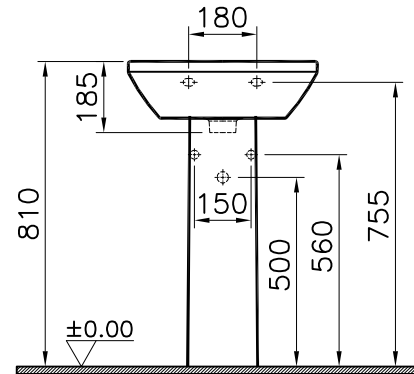
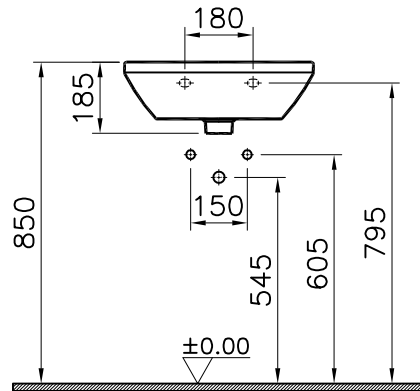
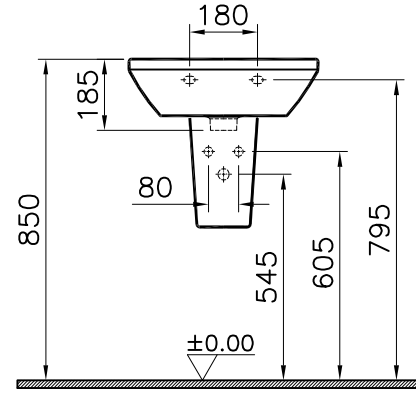
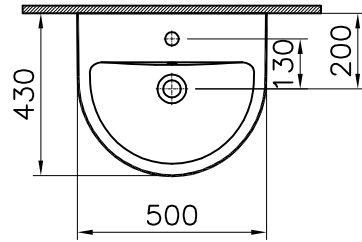

3	1	Pedestal	6936-0156	Ceramic	
2	1	Trap Cover (Small)	5316-0156	Ceramic	
1	1	Washbasin	7066-0001	Ceramic	
item	Quantity	Part Name	Drawing No	Material	Material Class
		Series	Material	Ceramic	Material Class
		S80	Washbasin		
Drawn By	Controlled By	Approved By	Date	Drawing No	Scale
G.GULTER	N.BALTACI	V.SARIGOL	12.09.2017	7066	1/20

R.S	Description	Date	NAME

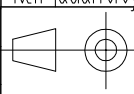

This drawing can only be used for the intended purposes. Unauthorized copying is strictly prohibited.

VitrA® ART^{EM}A