

STEINBERG



# Waschtisch-Einhebelmischbatterie

Art.Nr.250 1550

## Installation

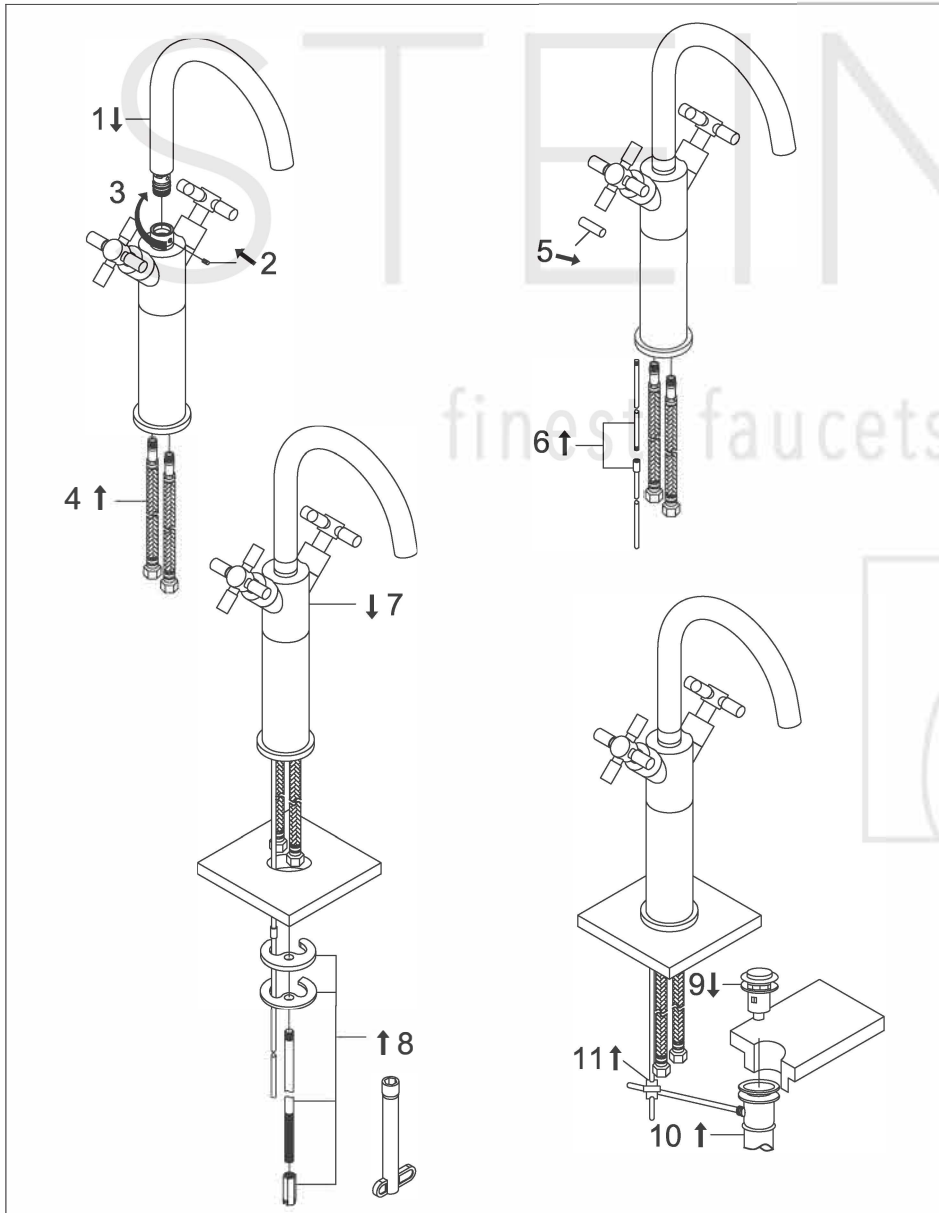

## Technische Zeichnung

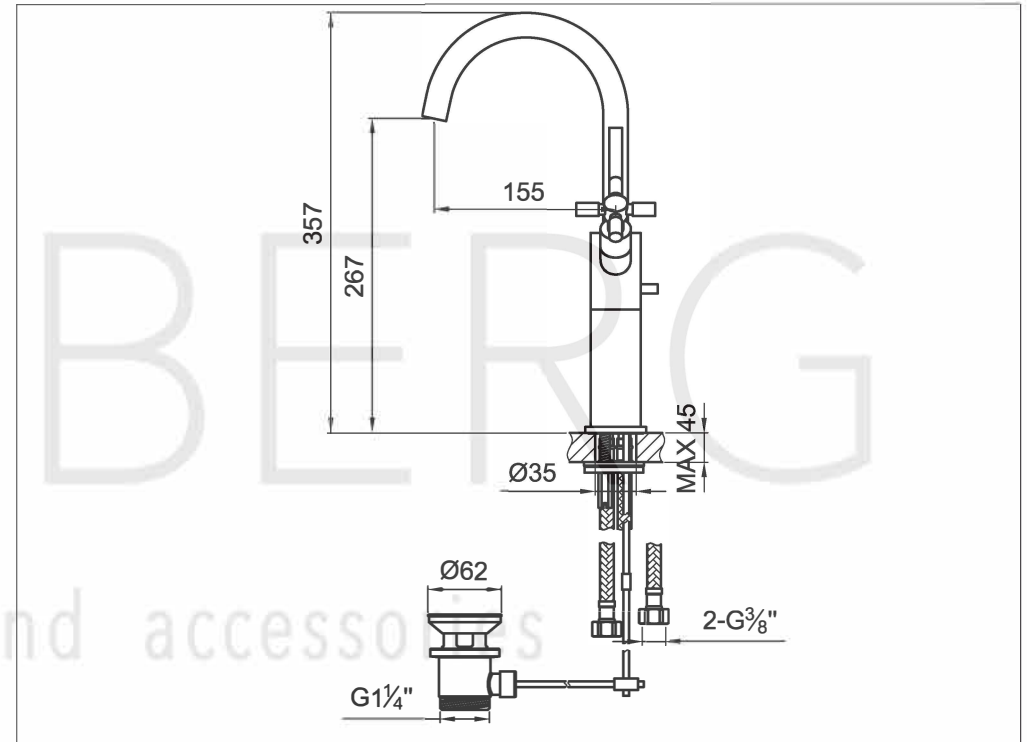

## Explosionszeichnung

