

A-A (1 : 10)

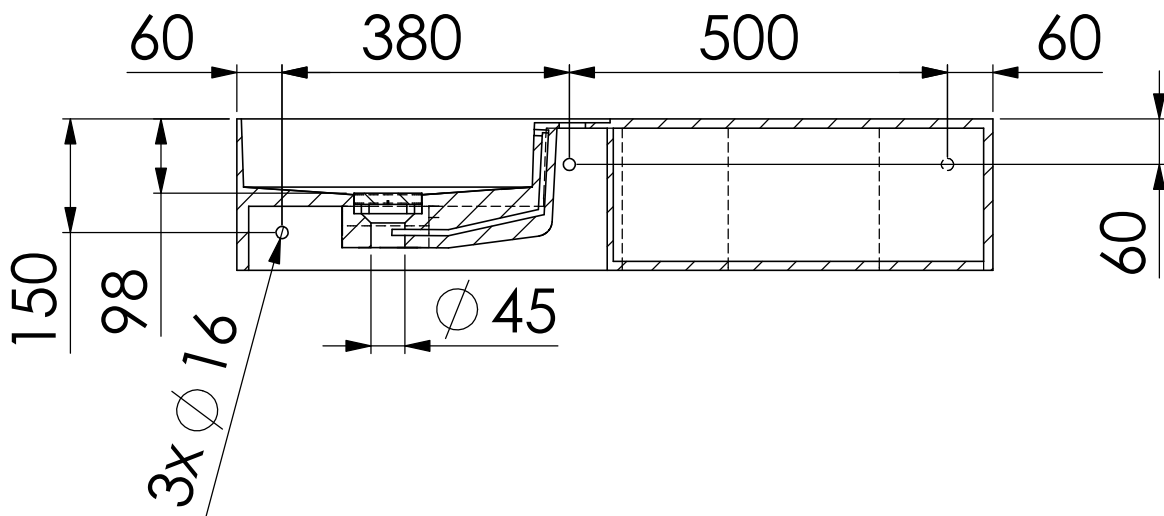

( Toleranz +/- 2 mm )

443 7130 W
STEINBERG
