

SCHNITT A-A

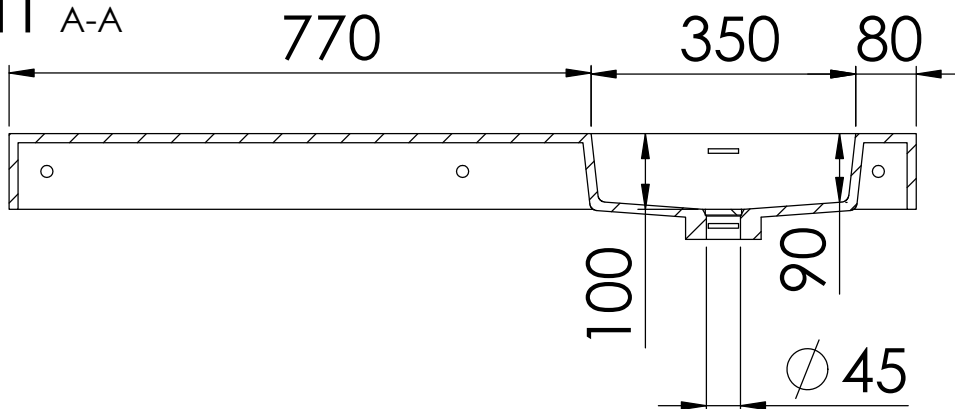

Toleranz / tolerance:
 30~120mm = +/- 4mm
 120~300mm = +/- 8mm

449 7120 W
 STEINBERG
