

DE Montageanleitung**EN** Mounting instruction**ES** Instrucciones de instalación**FR** Instructions d'installation**IT** Istruzioni per l'installazione**NL** Montagehandleiding**CS** Návod k instalaci**PL** Instrukcja montażu**RU** Инструкция по монтажу

59548 010201 59548 030201
 59548 050201 59548 070201
 59548 130201 59548 170201
 59548 370201

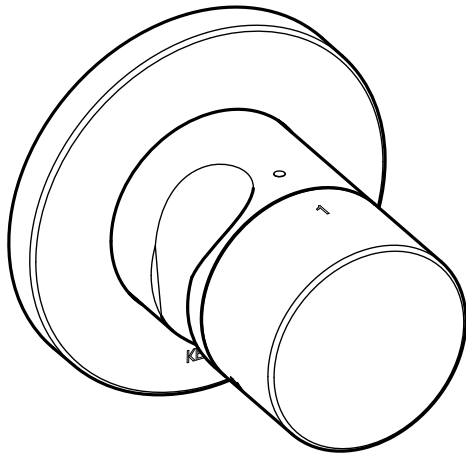

59548 010202 59548 030202
 59548 050202 59548 070202
 59548 130202 59548 170202
 59548 370202

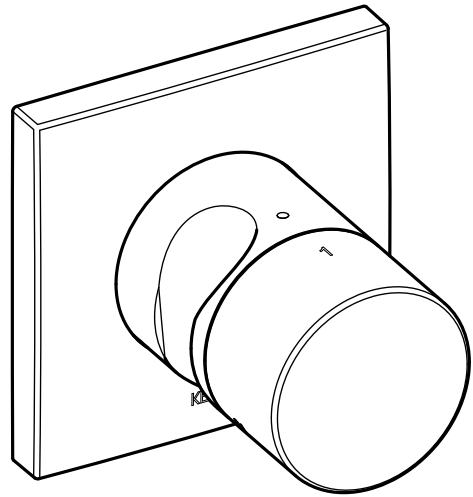
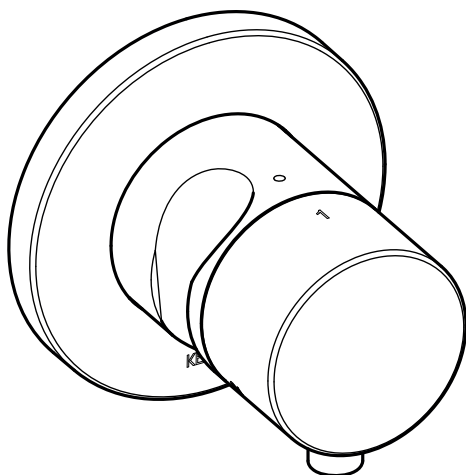

59548 011201 59548 031201
 59548 051201 59548 071201
 59548 131201 59548 171201
 59548 371201

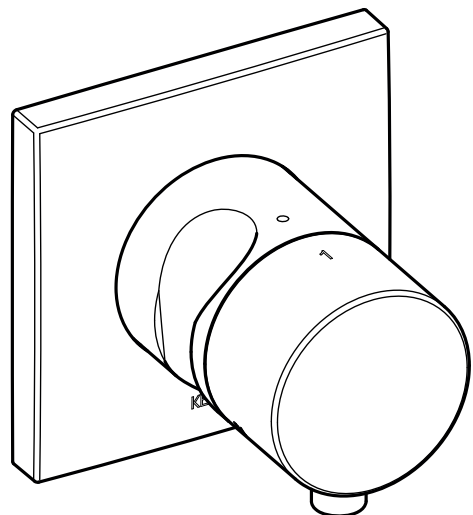

59548 011202 59548 031202
 59548 051202 59548 071202
 59548 131202 59548 171202
 59548 371202

DE Einbaumaße

FR Cotes de montage

CS Montážní rozměry

EN Mounting dimensions

IT Ingombro

PL Wymiary montażowe

ES Dimensiones de montaje

NL Montageafmetingen



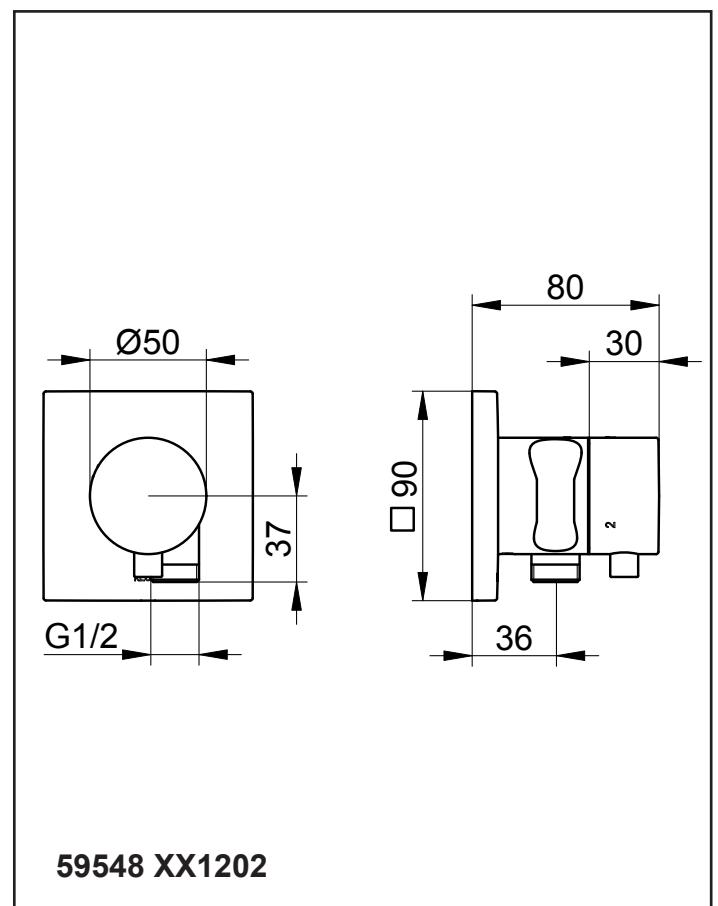
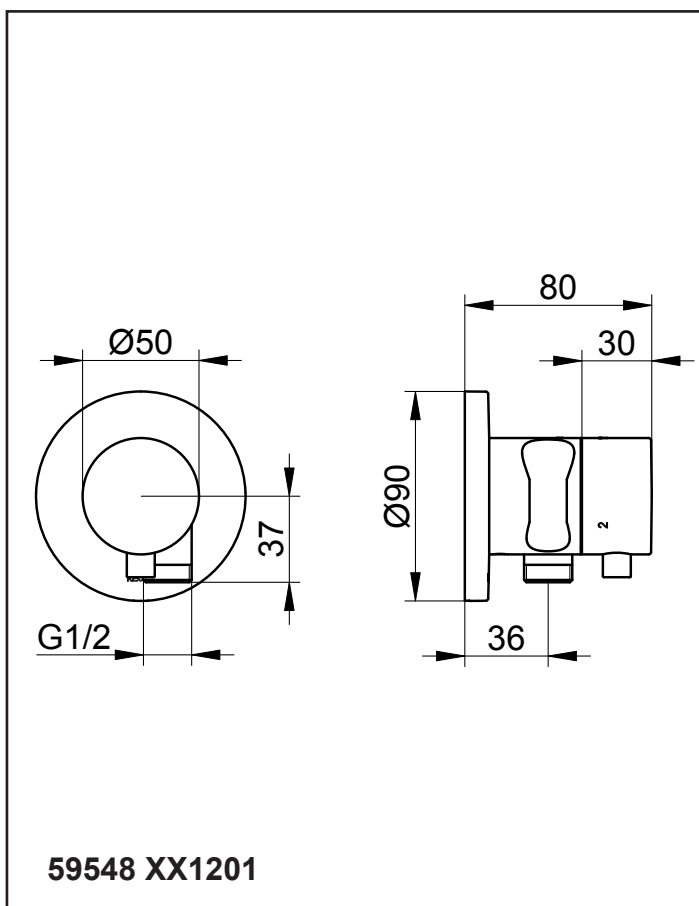
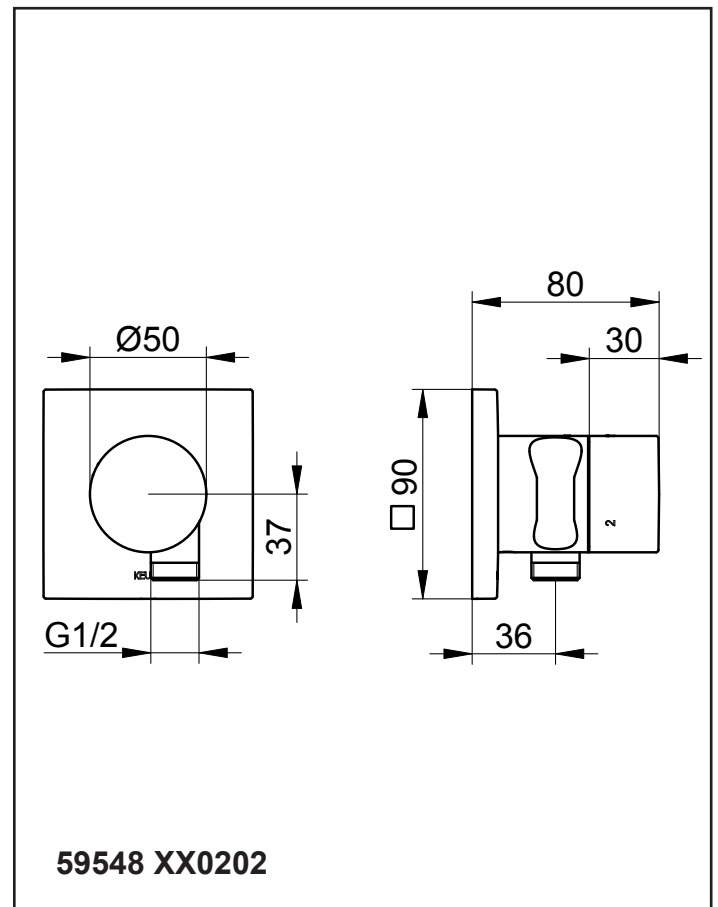
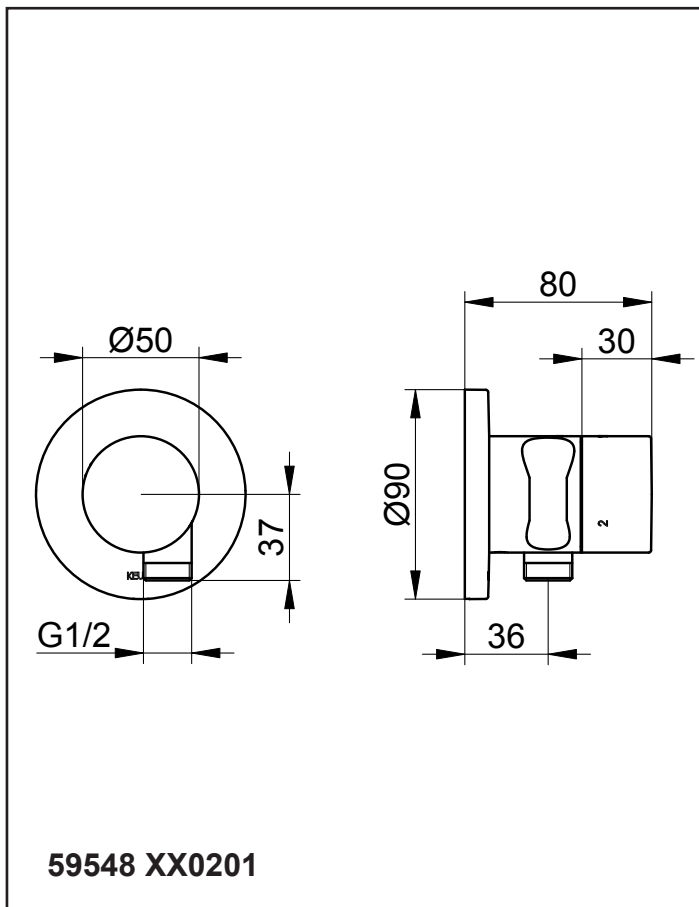







RU Монтажные размеры













 Diese Anleitung ist für den Installateur zur Montage sowie für den Nutzer zur Bedienung und Wartung des Produktes. Bitte nach der Installation an den Nutzer zur Verwahrung weitergeben.

 These instructions are for both the installer for installation and the user for operation and maintenance of the product. After installation, please hand them over to the user to keep.

Symbole und Bedeutung

-  **Achtung!** Warnung vor Personen- oder Sachschaden.
-  Hinweis, Tipp oder Verweis
-  Korrekte Montage/Funktionsprüfung
-  Falsche Montage
-  Montagedetail beachten
-  Kaltwasser  Warmwasser
-  Wasserfluss  Kein Wasserfluss
-  Optional/Zubehör

Symbols and explanations

-  **Attention!** Warning against bodily injury or damage to property.
-  Note, tip or reference
-  Correct installation/test of functionality
-  Incorrect installation
-  Observe installation details
-  Cold water  Hot water
-  Water flow  No water flow
-  Optional/accessories

Technische Daten

Durchfluss bei 3 bar Fließdruck
– Umstellventil: ca. 23 l/min
– Schlauchanschluss: ca. 16 l/min

Technical specifications

Flow at 3 bar pressure
– Diverter valve: approx. 23 l/min
– Wall outlet for shower hose: approx. 16 l/min

Einbaumaße, siehe Seite 2

Installation dimensions, refer to page 2

Installation, siehe ab Bild 1 auf Seite 8

 Nur neutral vernetzendes Silikon verwenden.

Installation, refer to picture 1 on page 8

 Use only neutrally netting silicone.

Bedienung, siehe Bild 11 auf Seite 10

Operation, refer to picture 11 on page 10

Wartung, siehe Bild 12 auf Seite 10

Montage in umgekehrter Reihenfolge.
– Anzugsmoment Kartuschenmutter: 20-30 Nm

Servicing, refer to picture 12 on page 10

Assemble in reverse order.
– Cartridge nut torque: 20-30 Nm

Ersatzteile mit Bestellnummern, siehe Seite 11

For spare parts with order numbers, refer to page 11

 Hinweise zur Gewährleistung und Pflege sind dem beiliegendem **Pflege- und Garantiepass** zu entnehmen.

 For warranty and care information please refer to the attached **warranty and care instructions**.

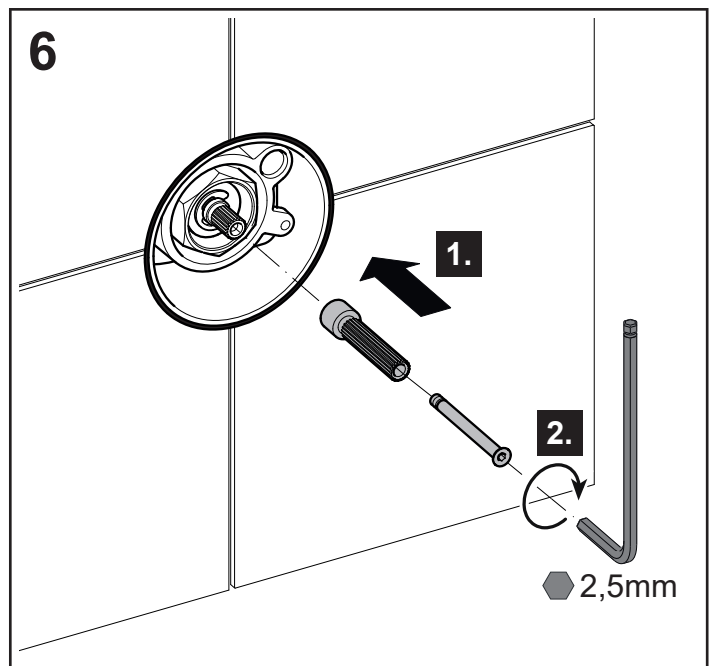
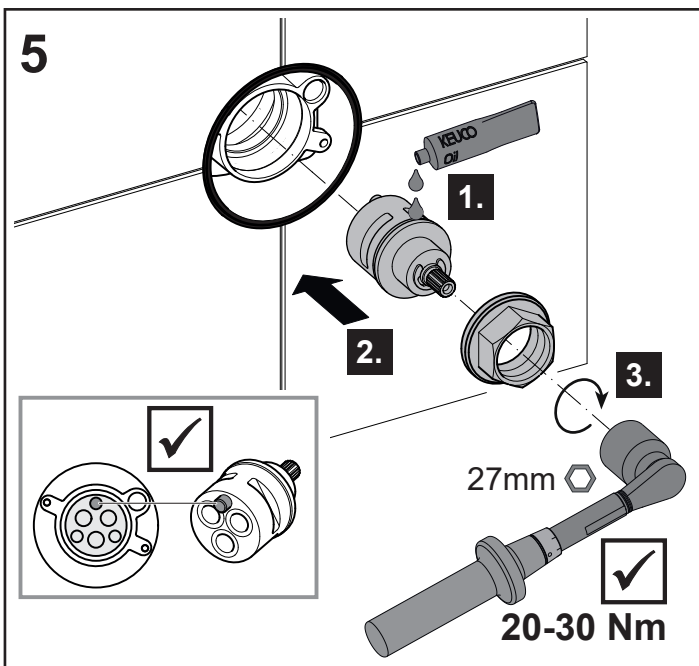
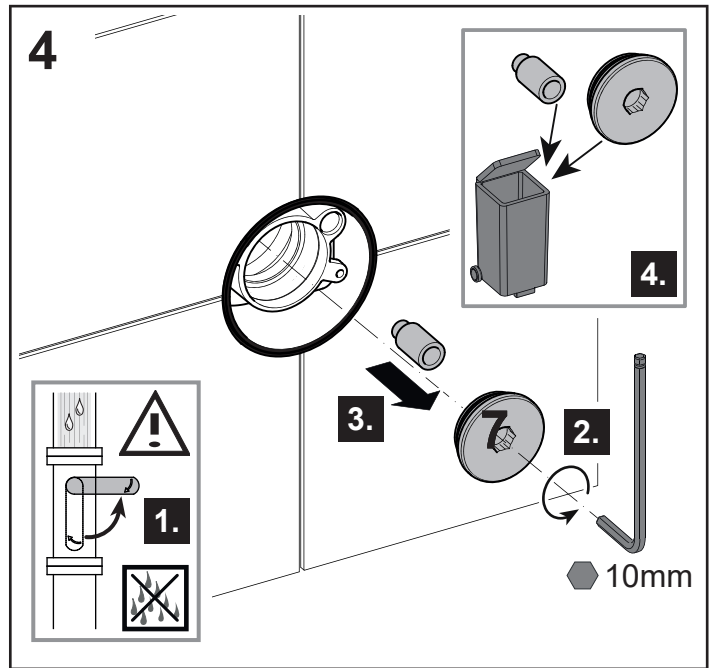
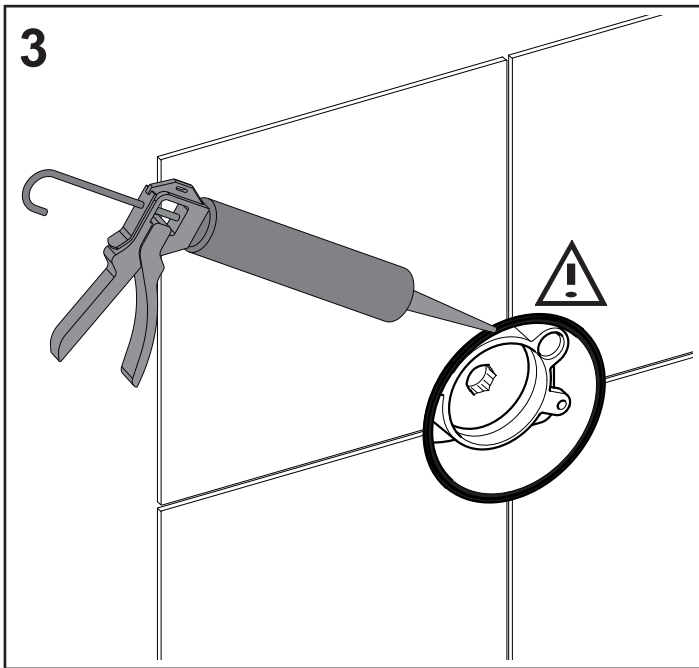
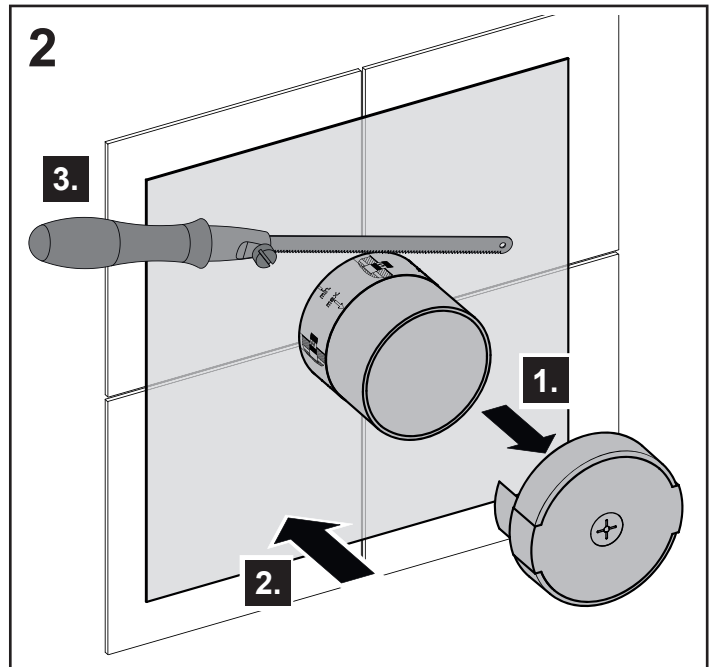
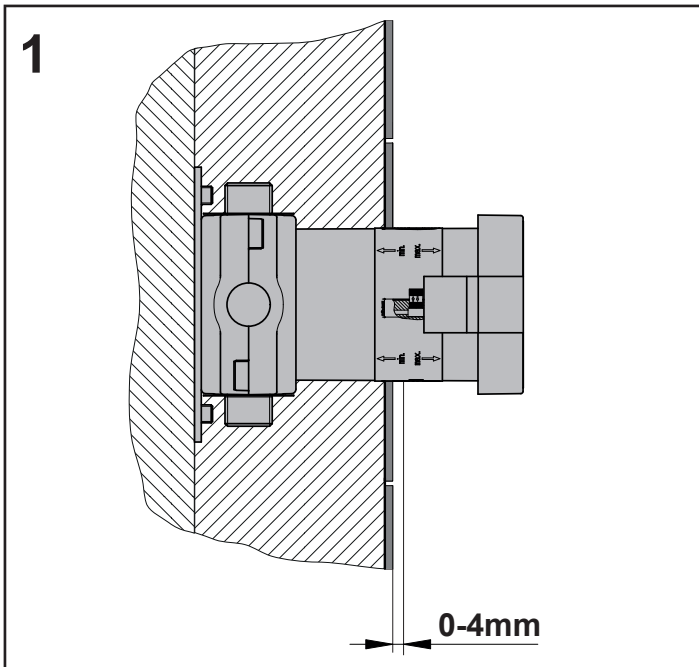

11

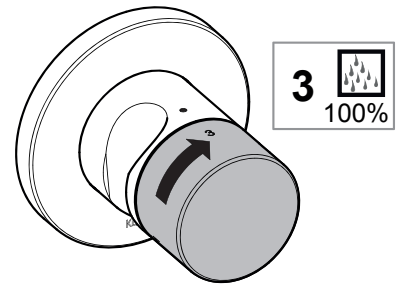
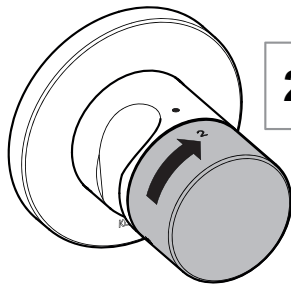
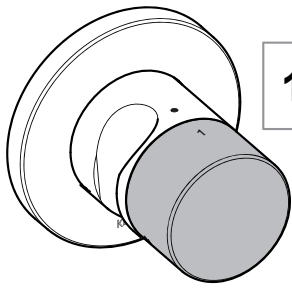
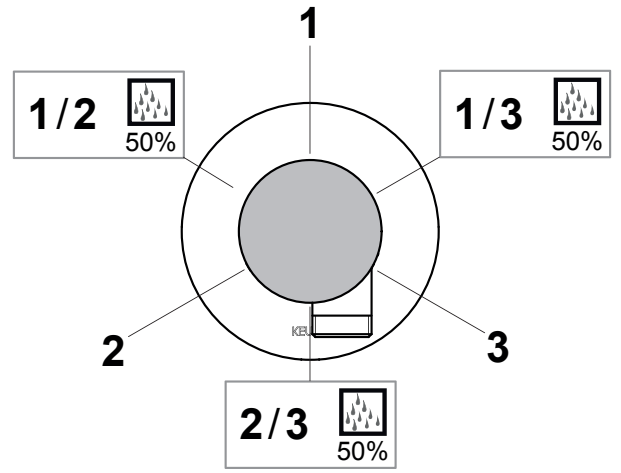
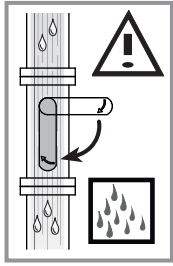

12

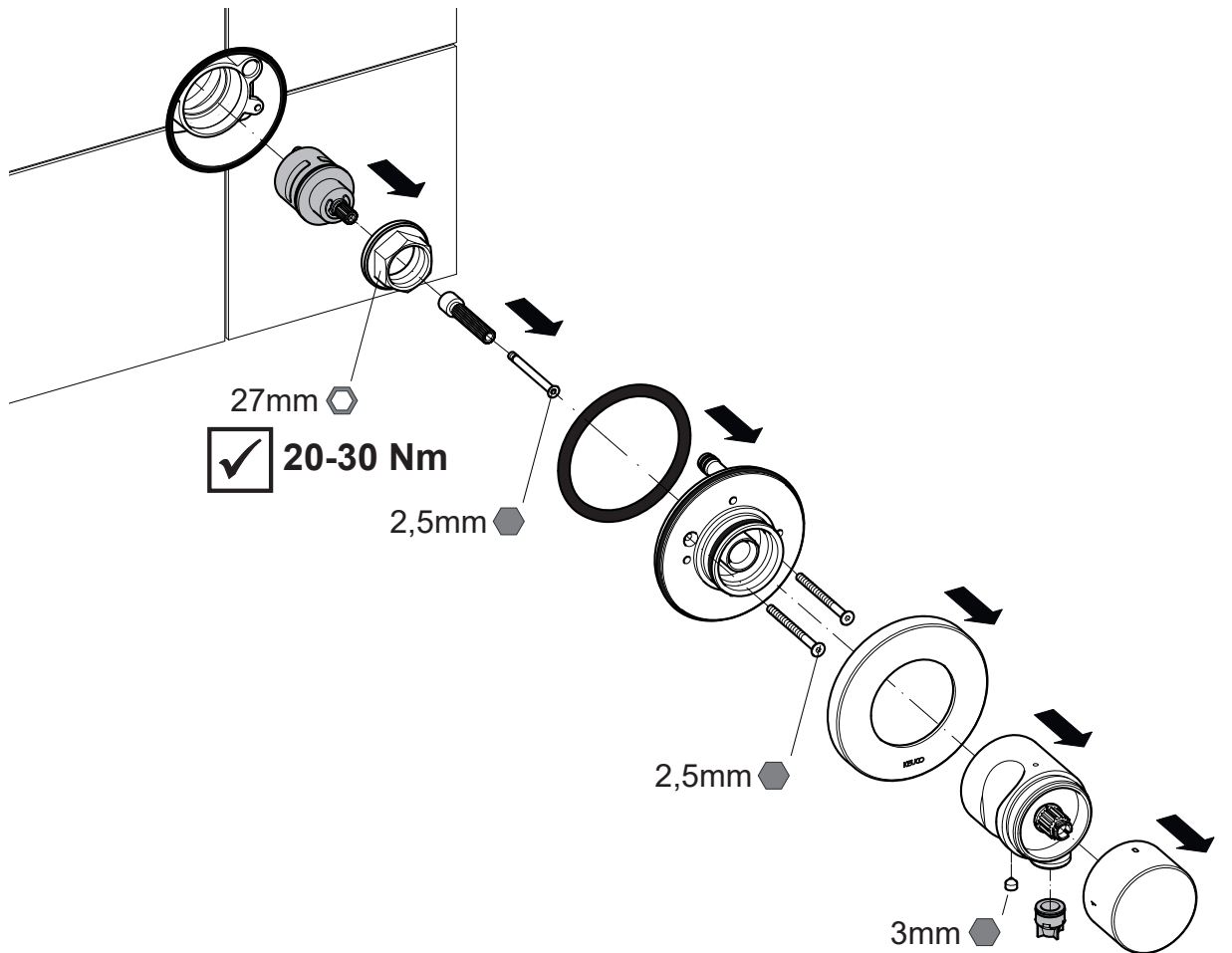

DE Ersatzteile

FR Pièces de rechange

CS Náhradní díly

EN Spare parts

IT Ricambi

PL Części zamienne

ES Piezas de recambio

NL Reserveonderdelen

RU Запчасти

